

Dual Monostable Multivibrators with Clear

These DC triggered multivibrators feature pulse width control by three methods. The basic pulse width is programmed by selection of external resistance and capacitance values. Once triggered, the basic pulse width may be extended by retriggering the gated low-level-active (A) or high-level-active (B) inputs, or be reduced by use of the overriding low-level clear. The Schmitt trigger inputs ensure jitter-free triggering from the B input with transition rates as slow as 0.1 millivolt per nanosecond.

- AVG's LS operates over extended V_{CC} from 4.5 to 5.5 V
- AVG's LS and ALS both have guaranteed DC and AC specification over full temperature and V_{CC} range
- Switching specifications for ALS at 50 pF
- AVG's ALS has the lowest speed power product (4pJ per gate typical) of all logic series

DV74LS123 DV74ALS123

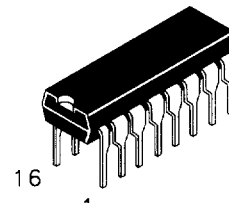

N Suffix
Plastic DIP
AVG-003 Case

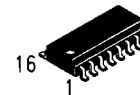

D Suffix
Plastic SOP
AVG-004 Case

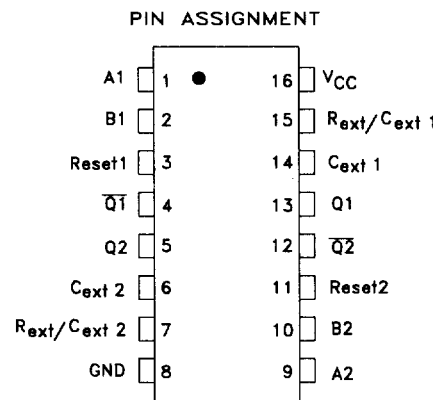
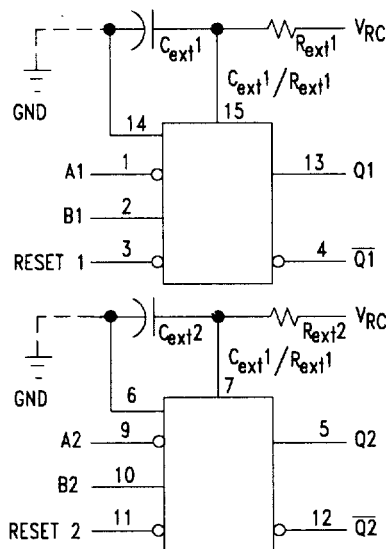

TRUTH TABLE

INPUTS			OUTPUTS	
Clear	A	B	Q	\bar{Q}
L	X	X	L	H
X	H	X	L	H
X	X	L	L	H
H	L	↑	↑↓	↓↑
H	↓	H	↑↓	↓↑
↑	L	H	↑↓	↓↑

L Low Level
H High Level
X Don't Care
↑ Low to High Transition
↓ High to Low Transition
↑↓ Low to High to Low Transition
↓↑ High to Low to High Transition

PIN 16 = V_{CC}
PIN 1,8,15 = GND
 R_{ext} AND C_{ext} ARE EXTERNAL COMPONENTS

NOTES:

1. An external timing capacitor may be connected between C_{EXT} and R_{EXT}/C_{EXT} (positive).
2. For improved pulse width accuracy connect an external resistor between R_{EXT}/C_{EXT} and V_{CC} .
3. To obtain variable pulse widths, connect an external variable resistance between R_{EXT}/C_{EXT} and V_{CC} .
4. C_{EXT} is connected internally to ground, however for best system performance, C_{EXT} should be hard-wired to ground.
5. V_{RC} is normally tied to V_{CC} , but can be connected to separate voltage source.

ABSOLUTE MAXIMUM RATINGS

Maximum ratings are those values beyond which damage to the device may occur.

Symbol	Parameter	LS123	ALS123	Unit
V_{CC}	Supply Voltage	7.0	7.0	V
V_{IN}	Input Voltage	-0.5 to +7.0	-0.5 to +7.0	V
T_{STG}	Storage Temperature Range	-65 to +150	-65 to +150	°C

GUARANTEED OPERATING CONDITIONS

Symbol	Parameter	LS123		ALS123		Unit
		Min	Max	Min	Max	
V _{CC}	Supply Voltage	4.5	5.5	4.5	5.5	V
V _{IH}	High Level Input Voltage	2.0		2.0		V
V _{IL}	Low Level Input Voltage		0.8		0.8	V
I _{OL}	Low Level Output Current		8.0		8.0	mA
I _{OH}	High Level Output Current		-0.4		-0.4	mA
R _{EXT}	External Timing Resistance	5.0	260	5.0	260	kΩ
C _{EXT}	External Capacitance	No Restriction		No Restriction		
R _{EXT} /C _{EXT}	Wiring capacitance at R _{EXT} /C _{EXT} terminal		50		50	pF
R _{EXT} /C _{EXT}	Wiring Capacitance at R _{EXT} /C _{EXT} Terminal		50		50	pF
T _A	Ambient Temperature Range	-10 to +70		-10 to +70		°C

DC ELECTRICAL CHARACTERISTICS over full operating conditions

Symbol	Parameter	Conditions	LS123			ALS123			Units
			Min	Typ	Max	Min	Typ	Max	
V _{IK}	Input Clamp Voltage	V _{CC} = min, I _{IN} = -18 mA			-1.5			-1.5	V
V _{OH}	High Level Output Voltage	V _{CC} =min, I _{OH} =Max	V _{CC} -2	3.5		V _{CC} -2			V
V _{OL}	Low Level Output Voltage (V _{IN} =V _{IL} or V _{IH} per truth table)	V _{CC} =min; I _{OL} =4.0mA		0.25	0.4		0.25	0.4	V
		V _{CC} =min; I _{OL} =8.0 mA		0.35	0.5		0.35	0.5	V
I _{IH}	High Level Input Current	V _{CC} =max, V _{IN} =2.7V			20			20	μA
	High Level Input Current	V _{CC} =max, V _{IN} = 7.0V			0.1			0.1	mA
I _{IL}	Low Level Input Current	V _{CC} =max, V _{IN} =0.4V			-0.4			-0.1	mA
I _O	Short Circuit Current One output shorted at a time	V _{CC} =max, V _O =2.25V	-20		-110	-30		-112	mA
I _{CC}	Supply Current	V _{CC} =max			20			10	mA

SWITCHING CHARACTERISTICS

Symbol	Parameter	Conditions	LS123		ALS123		Unit
			Min	Max	Min	Max	
t _{PLH}	Propagation Delay, A to Q	C _{EXT} =0 C _L =15pF		33		20	ns
t _{PHL}	Propagation Delay, A to \bar{Q}			45		25	ns
t _{PLH}	Propagation Delay, B to Q			44		25	ns
t _{PHL}	Propagation Delay, B to \bar{Q}	R _{EXT} =5.0kΩ R _L =2.0kΩ		56		30	ns
t _{PLH}	Propagation Delay, Clear to Q			27		15	ns
t _{PHL}	Propagation Delay, Clear to \bar{Q}			45		25	ns
t _{w min}	A or B to Q	C _{EXT} = 1000pF, R _L =2.0kΩ R _{EXT} =10kΩ, C _L =15pF,		200		120	ns
t _{wQ}	A to B to Q		4.0	5.0	4.0	5.0	μs

AC SETUP REQUIREMENTS over full operating conditions

Symbol	Parameter	Conditions	LS123		ALS123		Unit
			Min	Max	Min	Max	
t_w	Pulse Width	$V_{CC}=5.0$	40		30		ns

TYPICAL APPLICATION DATA

The output pulse t_w is a function of the external components, C_{EXT} and R_{EXT} . For values of $C_{EXT} \geq 1000$ pF, the output pulse at $V_{CC} = 5.0$ V and $V_{RC} = 5.0$ V is given by $t_w = K R_{EXT} C_{EXT}$ where K is nominally 0.45. If C_{EXT} is in pF and R_{EXT} is in k Ω then t_w is in nanoseconds.

The C_{EXT} terminal of the LS123 is an internal connection to ground, however, for the best system performance, C_{EXT} should be hard-wired to ground.

Care should be taken to keep R_{EXT} and C_{EXT} as close to the monostable as possible with a minimum amount of inductance between the R_{EXT}/C_{EXT} junction and the R_{EXT}/C_{EXT} pin. Good ground plane and adequate bypassing should be designed into the system for optimum performance to insure that no false triggering occurs.

To find the value of K for $C_{EXT} \geq 1000$ pF, refer to **Figure 1**. Variations on V_{CC} or V_{RC} can cause the value of K to change, as can the temperature of the LS123. **Figures 2 and 3** show the behavior of the circuit if separate power supplies are used for V_{CC} and V_{RC} . If V_{CC} is tied to V_{RC} , **Figure 4** shows how K will vary with V_{CC} and temperature.

As long as $C_{EXT} \geq 1000$ pF and $5K \leq R_{EXT} \leq 260$ K, the change in K with respect to R_{EXT} is negligible.

If $C_{EXT} \leq 1000$ pF the graph shown on **Figure 5** can be used to determine the output pulse width. **Figure 6** shows how K will change for $C_{EXT} \leq 1000$ pF if V_{CC} and V_{RC} are connected to the same power supply. The pulse width t_w in nanoseconds is approximated by

$$t_w = 6 + 0.05 C_{EXT} (pF) + 0.45 R_{EXT} (K\Omega) C_{EXT} + 11.6 R_{EXT}$$

Retriggering of the part must not occur before C_{EXT} is discharged or the retrigger pulse will not have any effect. The discharge time of C_{EXT} in nanoseconds is guaranteed to be less than $0.22 C_{EXT}$ (pF) and is typically $0.05 C_{EXT}$ (pF).

For the smallest possible deviation in output pulse widths from various devices, it is suggested that C_{EXT} be kept ≥ 1000 pF.

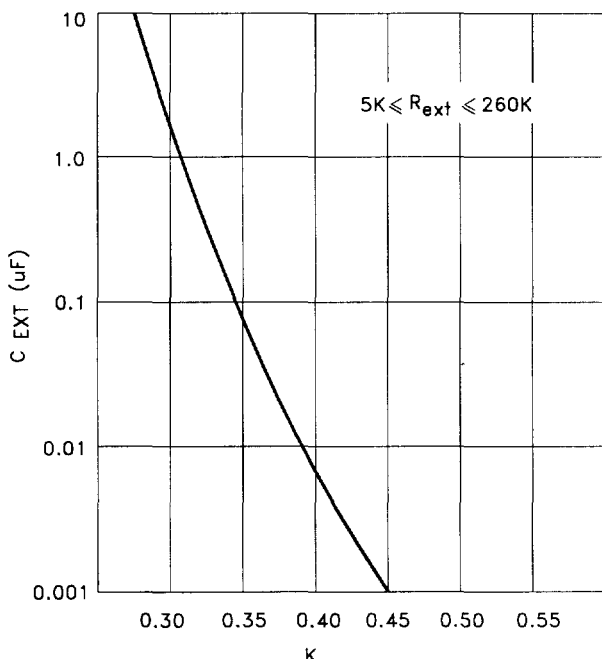

Figure 1

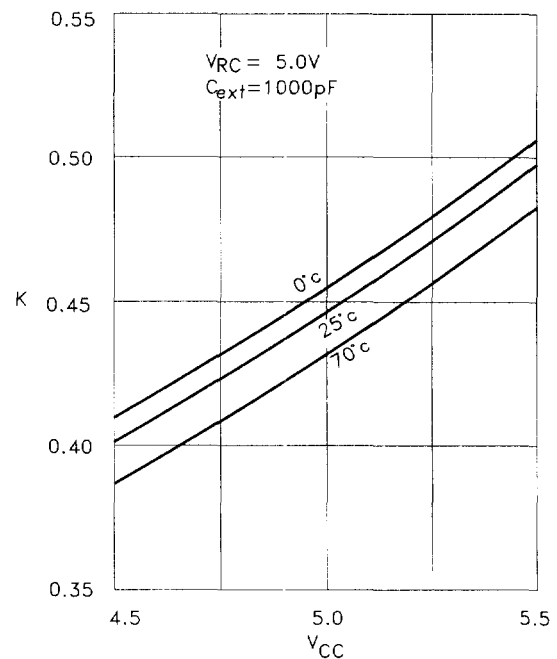

Figure 2

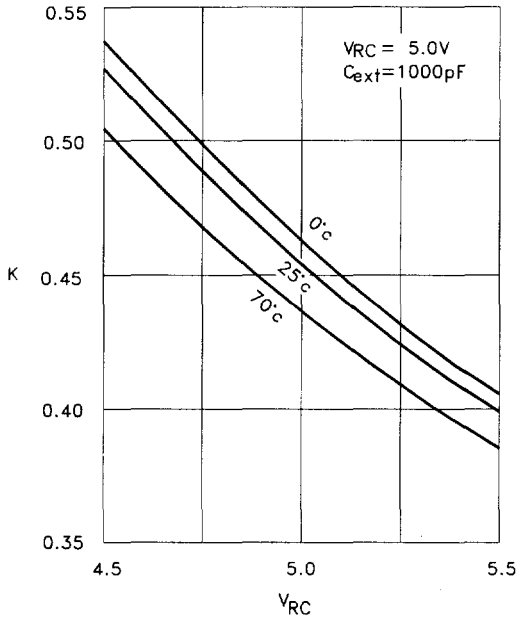

Figure 3

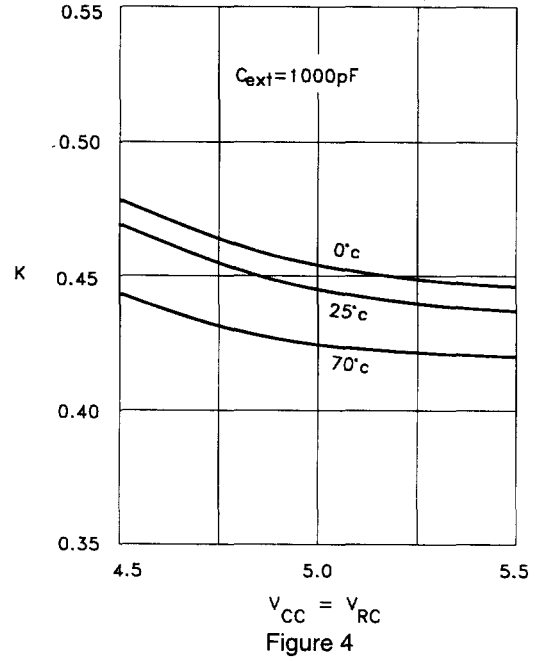

Figure 4

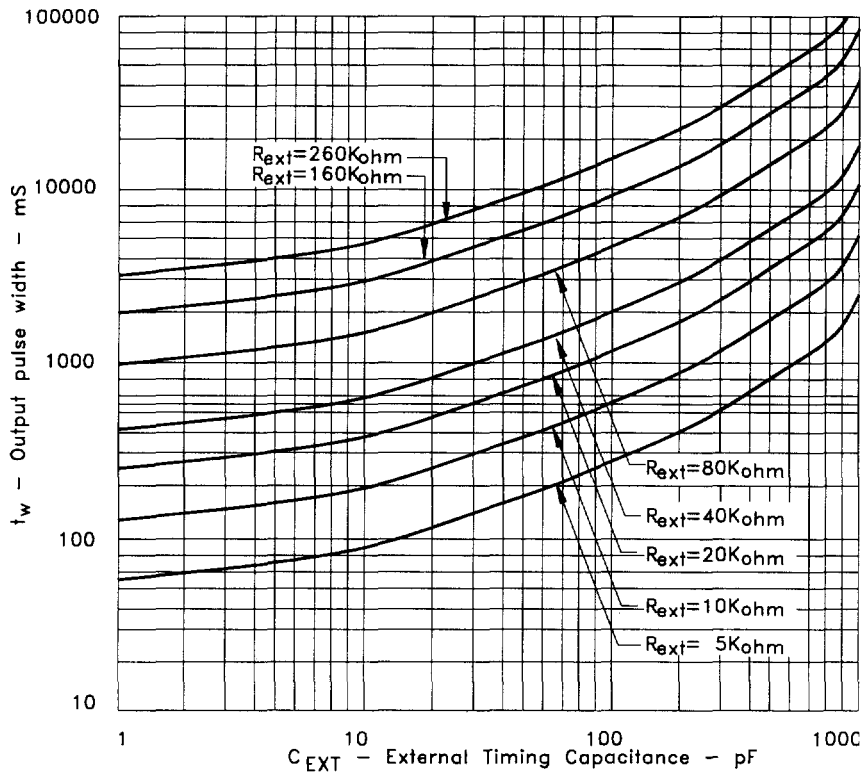

Figure 5

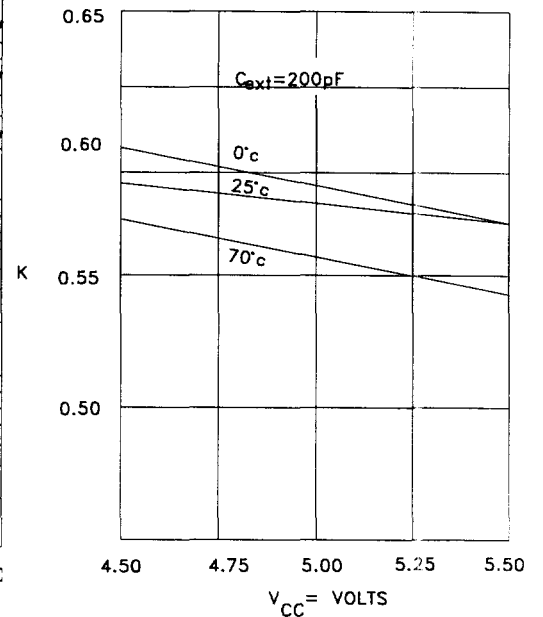

Figure 6